

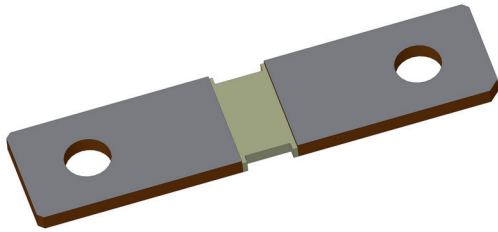

ISA-WELD® // PRECISION RESISTORS

**BAS** // SIZE 8420 (METRIC)**Features**

- Up to 30 W permanent power
- Continuous current load up to 350 A (0.1 mOhm)
- High pulse power rating
- Max. fastening torque 10 Nm
- Shunt available with tinned or untinned terminals
- Further versions with various dimensions upon request
- AEC-Q200 qualified

**Applications**

- Current sensor for EBM (Electronic Battery Management) in motorcars, trucks, forklifts, hybrid and electric vehicles
- Current sensing in bus bars
- Current sensing in welding equipments

Technical data

Resistance values	mOhm	0.035 / 0.05 / 0.1 / 0.2 / 0.5
Tolerance	%	5
Temperature coefficient (20-60 °C)	ppm/K	50
Applicable temperature range	°C	-40 to +170
Power rating	W	30 (0.035 mΩ)
Internal heat resistance (R _{thi})	K/W	see table on page 2
Thermal EMV (0-100 °C)	µV/K	0.6 (MANGANIN®) / 1 (ZERANIN®30)
Inductance	nH	<3
Stability (Nominal load) deviation after 2,000 h		<0.5 % (T _k = 105 °C)
T _k = Terminal temperature		<1.0 % (T _k = 140 °C)

Packaging Information

140 pcs. per tube for automotive parts

100 pcs. sealed in plastic bags evacuated and refilled with dry nitrogen



BAS // SIZE 8420 (METRIC)

Mechanical dimensions [mm] // Z-YJ-328

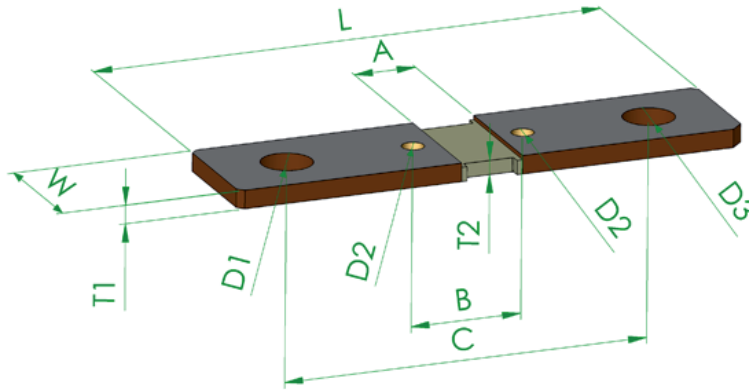

type	A	B	C	D1	D2	D3	L	T1	T2	W
BAS-M-R0001-E-5.0	10.1±0.5	-	60±0.2	Ø8.3±0.1	-	Ø8.3±0.1	84±0.2	3±0.15	2.3±0.2	20±0.1
BAS-M-R0001-AE-5.0	10.1±0.5	-	60±0.2	Ø8.3±0.1	-	Ø8.3±0.1	84±0.2	3±0.15	2.3±0.2	20±0.1
BAS-M-R0001-L-5.0	10.1±0.5	-	51±0.2	Ø8.3±0.1	-	Ø8.3±0.1	68±0.2	3±0.15	2.3±0.2	20±0.1
BAS-M-R0001-R-5.0	10.1±0.5	18.2±0.1	60±0.2	Ø8.3±0.1	3.62±0.08	Ø8.3±0.1	84±0.2	3±0.15	2.3±0.2	20±0.1

Further versions on request

Type	Value [mΩ]	R _{thi} [K/W]	TC [ppm/K]	P _{140°C} [W]
BAS-Z-R000035	0.035	1.0	100	30
BAS-M-R00005	0.05	1.5	100	20
BAS-M-R0001	0.1	2.0	50	15
BAS-M-R0002	0.2	3.0	50	10
BAS-M-R0005	0.5	7.0	50	4

Abbreviation type: M=MANGANIN®, Z=ZERANIN®30

Ordering code example

BAS - M - R0001 - A E - 5.0

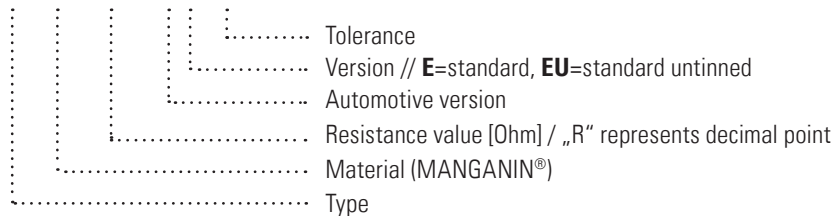

Connection diagram

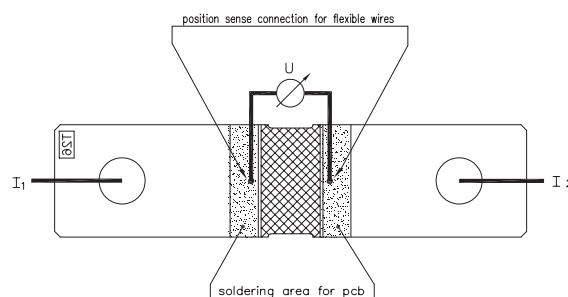

Z-DR-159a



BAS // SIZE 8420 (METRIC)

Temperature dependence of the electrical resistance

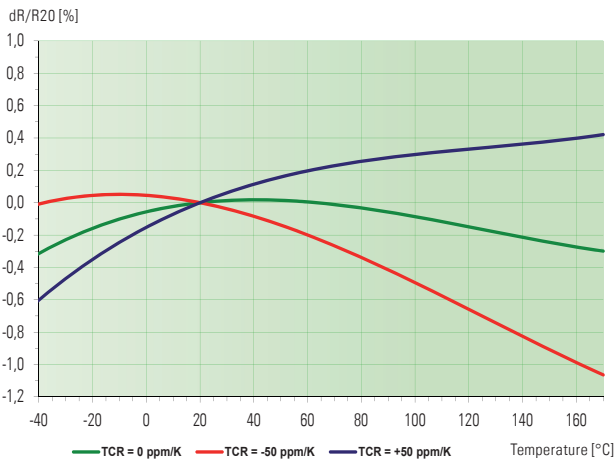

Power derating curve, R=0.1 mOhm

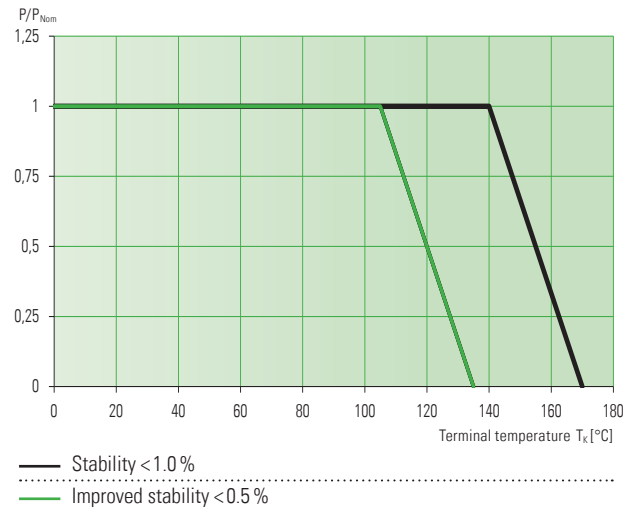

Maximum pulse energy respectively pulse power for permanent operation

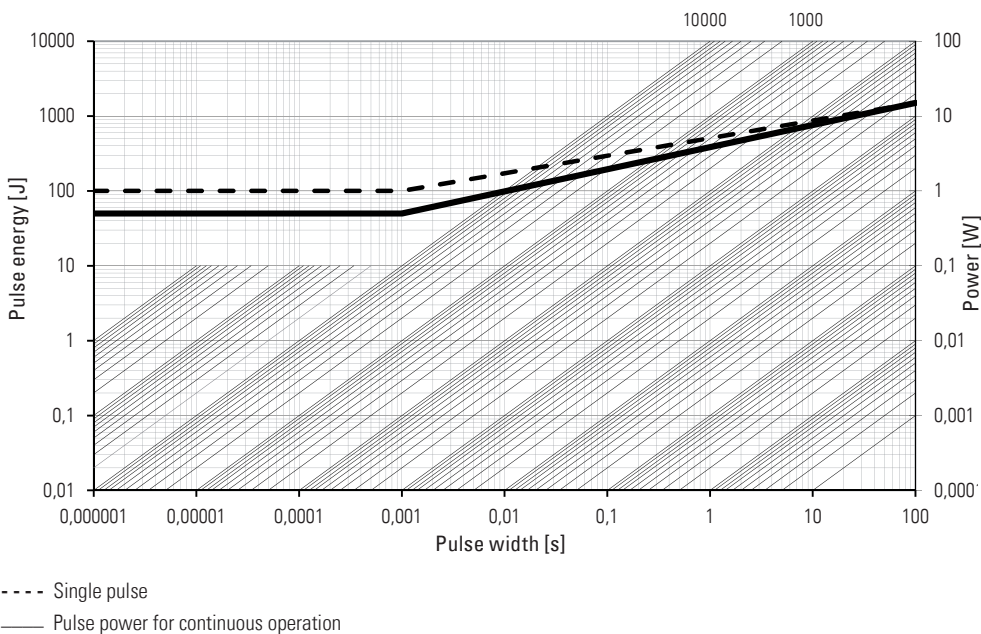

This curve is only valid for the resistance value R0001. The shape of the curve in the range below 0.1 sec will be different for other resistance values. Therefore a separate qualification should be made for pulse power close to the above curve.

Disclaimer // All products, product specifications and data are subject to change without notice. The product specifications do not expand or otherwise modify Isabellenhütte's terms and conditions of sale, including but not limited to, the warranty expressed therein. Isabellenhütte makes no warranty, representation or guarantee other than as set forth in its terms and conditions of sale. Information provided in datasheets and/or specifications may vary from actual results in different applications. Any statements made by Isabellenhütte regarding the suitability of products for certain types of applications are based on its knowledge of typical requirements that are often placed on its products. It is the customer's responsibility to validate that a particular product with the properties described in the product specification is suitable for use in the application intended. No license, express or implied, or otherwise, to any intellectual property rights is granted by this document. Any and all liability arising out of the application or use of any product shall be as set forth in Isabellenhütte's terms and conditions of sale.

