

ISA-PLAN® // PRECISION RESISTORS

SMV-PW // Size 4723

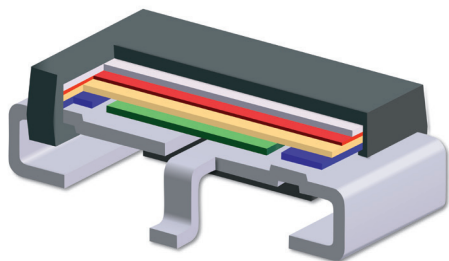

Features

- 3 W permanent power at 80 °C
- Continuous current load up to 30 A (3.3 mOhm)
- Excellent long-term stability
- High pulse power rating
- Mounting: reflow-, IR- and wave-soldering
- *Detail specification ESCC 4001/028*
- SnPb tinned contacts

Applications

- Aerospace



Technical data

Resistance values	Ohm	0.0033 to 1 *
Tolerance	%	0.5 / 1 *
Temperature coefficient (22-60 °C)	ppm/K	≤50ppm/K <i>for</i> ≤10 mΩ ≤30ppm/K <i>for</i> >10 mΩ
Applicable temperature range	°C	-55 to +140
Power rating	W	3
Internal heat resistance (R _{thi})	K/W	<20
Isolation voltage	V AC/DC	1000
Stability (Nominal load) deviation after 2000h, T _K = Terminal temperature		<0.2% (T _K =80 °C)

* For detailed information see table on page 2

Temperature dependence of the electrical resistance of MANGANIN® resistors at +22°C to +60°C

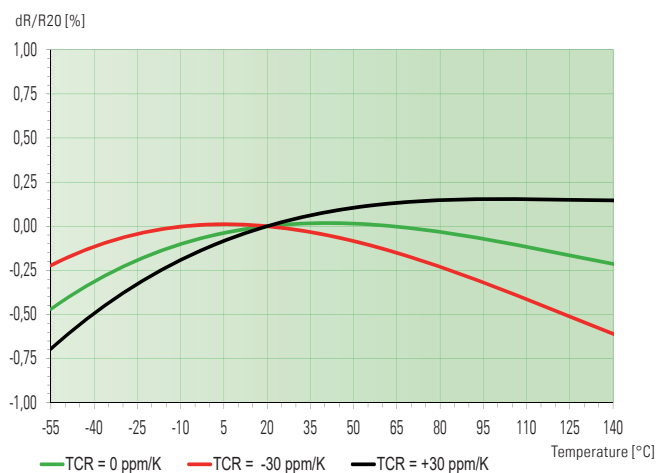

Power derating curve

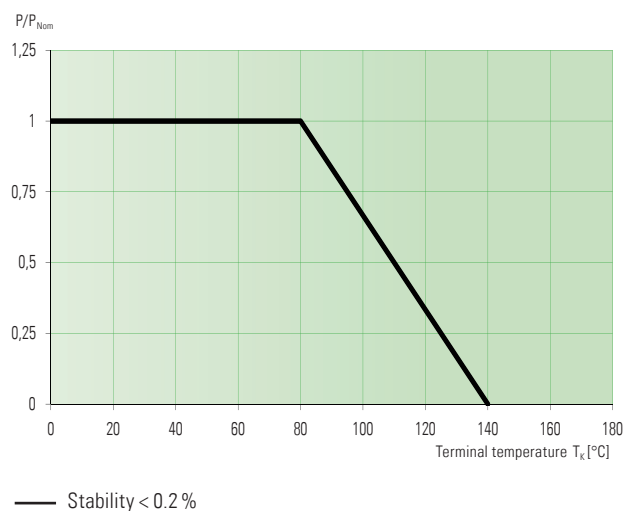



SMV-PW // Size 4723

Recommended solder profile

Reflow-, IR- and wave-soldering

Temperature	°C	260	255	217
Time	sec	peak	40	90

Packaging information

Specification	DIN EN 60286-3		
Tape width	mm	24	
Reel size	inch	13	

Form of delivery

Tape	pcs	up to 300
Tape and reel	pcs	>300

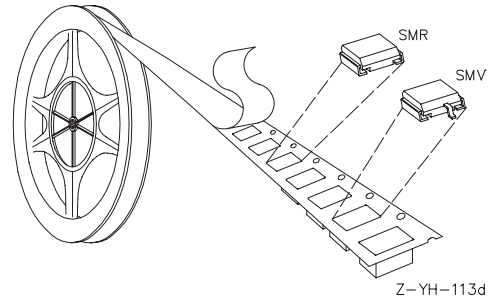

Available standard resistance values and tolerances

Ordering code	ESCC component number
SMV-R0033-1.0-PW	ESCC 400102802R0033F
SMV-R0039-1.0-PW	ESCC 400102802R0039F
SMV-R005-1.0-PW	ESCC 400102802R005F
SMV-R0068-1.0-PW	ESCC 400102802R0068F
SMV-R010-0.5-PW	ESCC 400102802R01D
SMV-R010-1.0-PW	ESCC 400102802R01F
SMV-R015-0.5-PW	ESCC 400102802R015D
SMV-R015-1.0-PW	ESCC 400102802R015F
SMV-R018-0.5-PW	ESCC 400102802R018D
SMV-R018-1.0-PW	ESCC 400102802R018F
SMV-R020-0.5-PW	ESCC 400102802R02D
SMV-R020-1.0-PW	ESCC 400102802R02F
SMV-R022-0.5-PW	ESCC 400102802R022D
SMV-R022-1.0-PW	ESCC 400102802R022F
SMV-R027-0.5-PW	ESCC 400102802R027D
SMV-R033-0.5-PW	ESCC 400102802R033D
SMV-R033-1.0-PW	ESCC 400102802R033F
SMV-R039-0.5-PW	ESCC 400102802R039D
SMV-R039-1.0-PW	ESCC 400102802R039F
SMV-R047-0.5-PW	ESCC 400102802R047D
SMV-R047-1.0-PW	ESCC 400102802R047F
SMV-R050-1.0-PW	ESCC 400102802R05F
SMV-R056-0.5-PW	ESCC 400102802R056D

Ordering code	ESCC component number
SMV-R056-0.5-PW	ESCC 400102802R056D
SMV-R056-1.0-PW	ESCC 400102802R056F
SMV-R068-0.5-PW	ESCC 400102802R068D
SMV-R068-1.0-PW	ESCC 400102802R068F
SMV-R082-0.5-PW	ESCC 400102802R082D
SMV-R100-0.5-PW	ESCC 400102802R1D
SMV-R100-1.0-PW	ESCC 400102802R1F
SMV-R120-1.0-PW	ESCC 400102802R12F
SMV-R150-0.5-PW	ESCC 400102802R15D
SMV-R150-1.0-PW	ESCC 400102802R15F
SMV-R180-0.5-PW	ESCC 400102802R18D
SMV-R180-1.0-PW	ESCC 400102802R18F
SMV-R200-1.0-PW	ESCC 400102802R2F
SMV-R220-0.5-PW	ESCC 400102802R22D
SMV-R220-1.0-PW	ESCC 400102802R22F
SMV-R270-1.0-PW	ESCC 400102802R27F
SMV-R330-0.5-PW	ESCC 400102802R33D
SMV-R330-1.0-PW	ESCC 400102802R33F
SMV-R470-0.5-PW	ESCC 400102802R47D
SMV-R470-1.0-PW	ESCC 400102802R47F
SMV-R560-0.5-PW	ESCC 400102802R56D
SMV-R680-0.5-PW	ESCC 400102802R68D
SMV-R680-1.0-PW	ESCC 400102802R68F

* other resistance values on request

Ordering code

SMV - R010 - 1.0 - PW

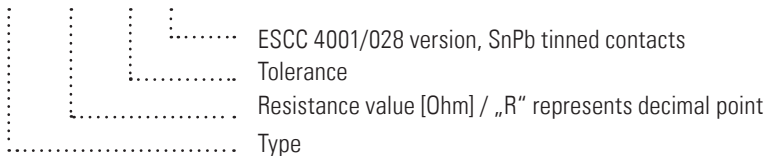



SMV-PW // Size 4723

Mechanical dimensions [mm]

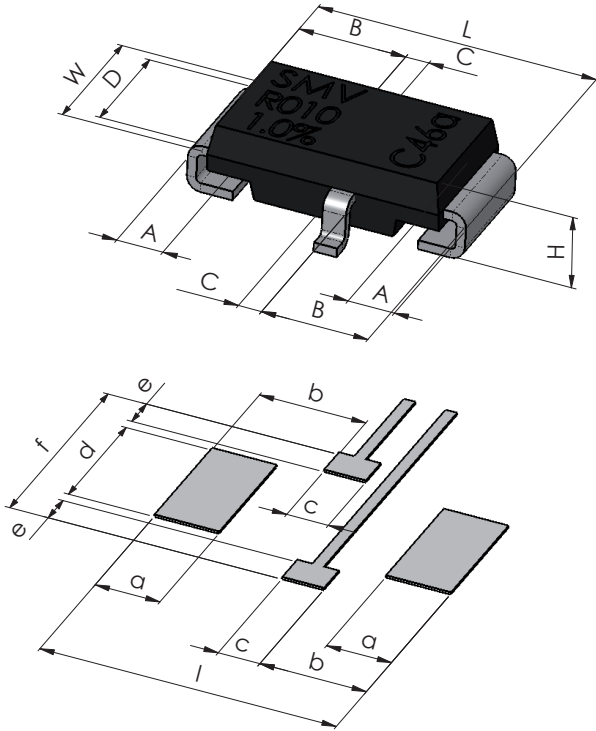

Pcb-layout proposal (Reflow-soldering) [mm]

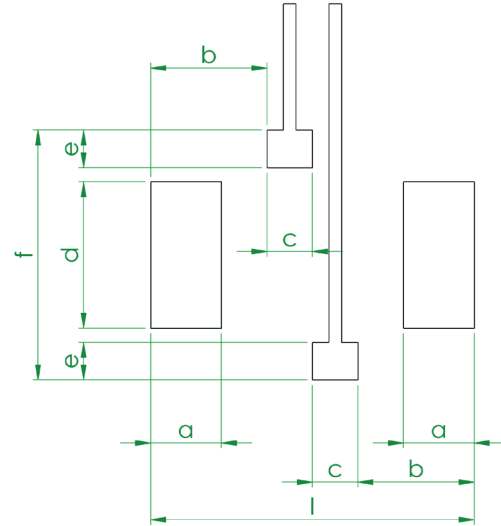

type	L	W	H	A	B	C	D
SMV	12.0 +0.3/-0.1	6.0 +0.6/-0.1	3.4 +0.2/-0.2	2.0 ±0.5	4.6 ±0.3	1.0 +0.3/-0.2	5.0 +0.3/-0.1

solder pad type	l	a	b	c	d	e	f
SMV	12.8	2.8	4.6	1.8	5.8	1.5	9.9

Disclaimer // All products, product specifications and data are subject to change without notice.

The product specifications do not expand or otherwise modify Isabellenhütte's terms and conditions of sale, including but not limited to, the warranty expressed therein. Isabellenhütte makes no warranty, representation or guarantee other than as set forth in its terms and conditions of sale.

Information provided in datasheets and/or specifications may vary from actual results in different applications. Any statements made by Isabellenhütte regarding the suitability of products for certain types of applications are based on its knowledge of typical requirements that are often placed on its products. It is the customer's responsibility to validate that a particular product with the properties described in the product specification is suitable for use in the application intended.

No license, express or implied, or otherwise, to any intellectual property rights is granted by this document.

Any and all liability arising out of the application or use of any product shall be as set forth in Isabellenhütte's terms and conditions of sale.

